

Vise Grips

Vise grips to fix samples to a test stand.

Vise grips for multi purposes.

Variety of vise is available depending on sample materials and measurement



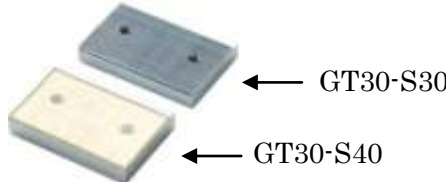

<p>Standard Type (Lever) Vise grip with one side open.</p>	<p>Model: GT-30 Capacity: 1000N Grip Width: 38mm Opening Width: 38mm Weight: Approx. 1100g</p>	
<p>Hard Grip Type (Lever) Vise grip with one side open and both jaws have nicks. Suitable for slippery samples.</p>	<p>Model: GT-30-E Capacity: 1000N Grip Width: 38mm Opening Width: 35mm Weight: Approx. 1100g</p>	
<p>Polyurethane Grip Type (Lever) Vise grip with one side open and a jaw has polyurethane. Suitable for delicate films as urethane avoids breaking films.</p>	<p>Model: GT-30-U Capacity: 250N Grip Width: 38mm Opening Width: 35mm Weight: Approx. 1100g</p>	
<p>High capacity Type (Lever) Vise grip up to 2000N with one side open for bigger samples. Fixable by front or side lever direction on a test stand.</p>	<p>Model: GT-2000N Capacity: 2000N Grip Width: 62mm Opening Width: 64mm Weight: Approx. 4400g</p>	
<p>Double Opening Type (Lever) Easy positioning with both sides simultaneously open. Lever makes possible to fix firmly. * Not suitable for short and small samples</p>	<p>Model: GTW-50L Capacity: 1000N Grip Width: 50mm Opening Width: 68mm Weight: Approx. 3kg</p>	
<p>Double Opening Type (Knob) Easy positioning with both sides simultaneously open. Knob makes easy operation. * Not suitable for short and small samples</p>	<p>Model: GTW-50R Capacity: 500N Grip Width: 50mm Opening Width: 68mm Weight: Approx. 3kg</p>	

April 05, 2012

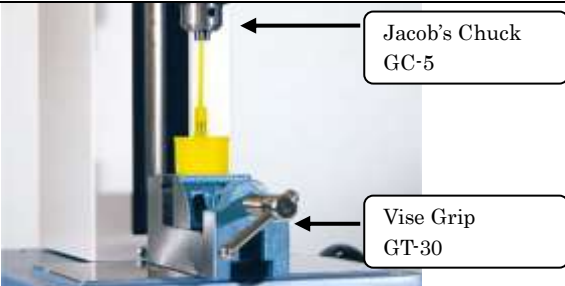
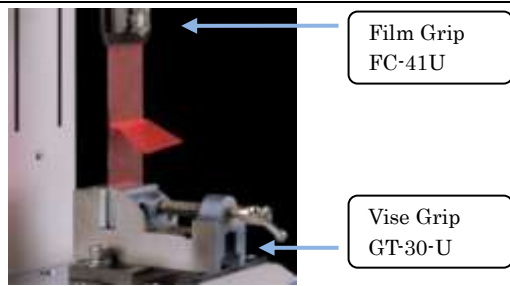
1 / 4

Options	
Vise Jaws for GT-30-E GT30-S10	Vise Jaws for GT-30-U GT30-S30 (nick side) GT30-S40 (polyurethane side)
	
*Attachable to GT-30 (standard type) *This model is sold in 1 piece. Please order 2 pieces when used for both sides.	*Attachable to GT-30 (standard type) *This model is sold in 1 piece.

Measurement Example	
Stuffing and pulling out test of plastic materials	180 degrees peeling test of film
	
Jacob's Chuck GC-5 Vise Grip GT-30	Film Grip FC-41U Vise Grip GT-30-U

Attachable Test Stands			
Motorized Test Stand		Manual Test Stand	
MX-500N	MX2-500N	SVL-1000N	HV-500N2
MX-1000N	MX2-1000N	SVH-1000N	HV-1000N
MX-2000N	MX2-2500N		HV-3000N
MX-5000N	EMX-1000N		
			

April 05, 2012

[Dimensions]

GT-30

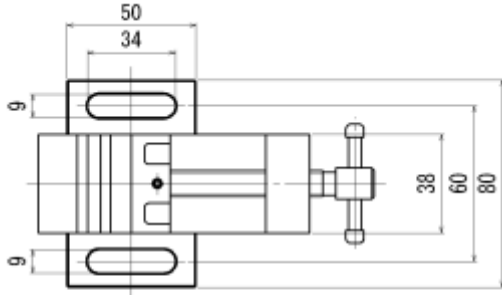

	Opening width
GT-30	Max. 38mm
GT-30-E	Max. 35mm
GT-30-U	Max. 35mm

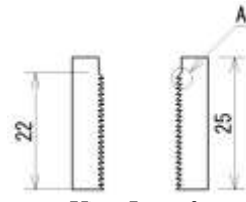

Vise Jaws for GT-30-E

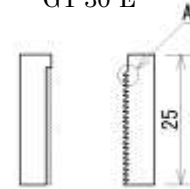

Vise jaws for GT-30-U

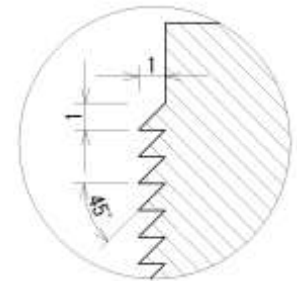
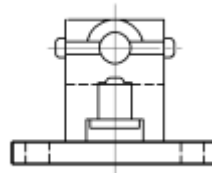
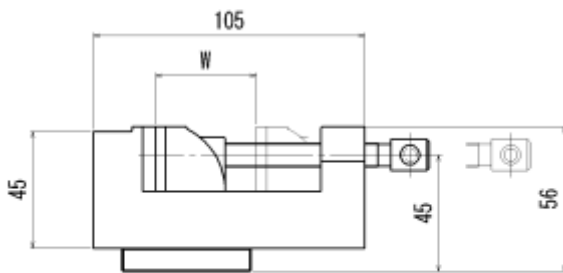

Enlarged A

GTW-50R

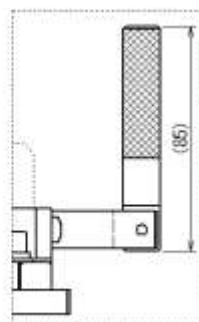
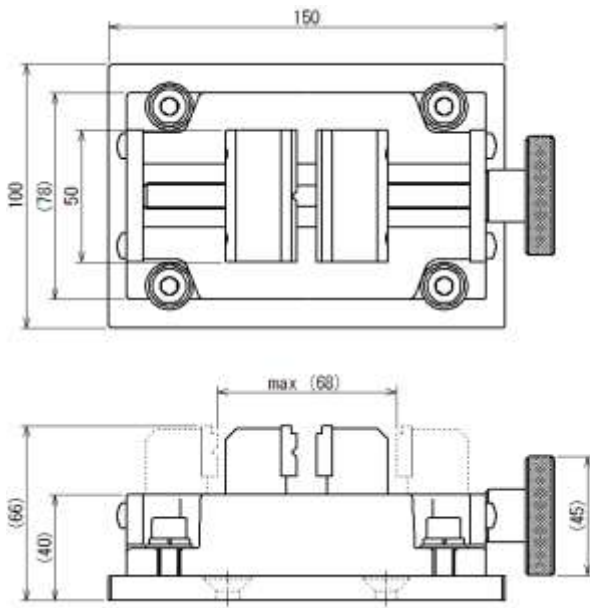

Lever of GTW-50L

April 05, 2012

GT-2000N

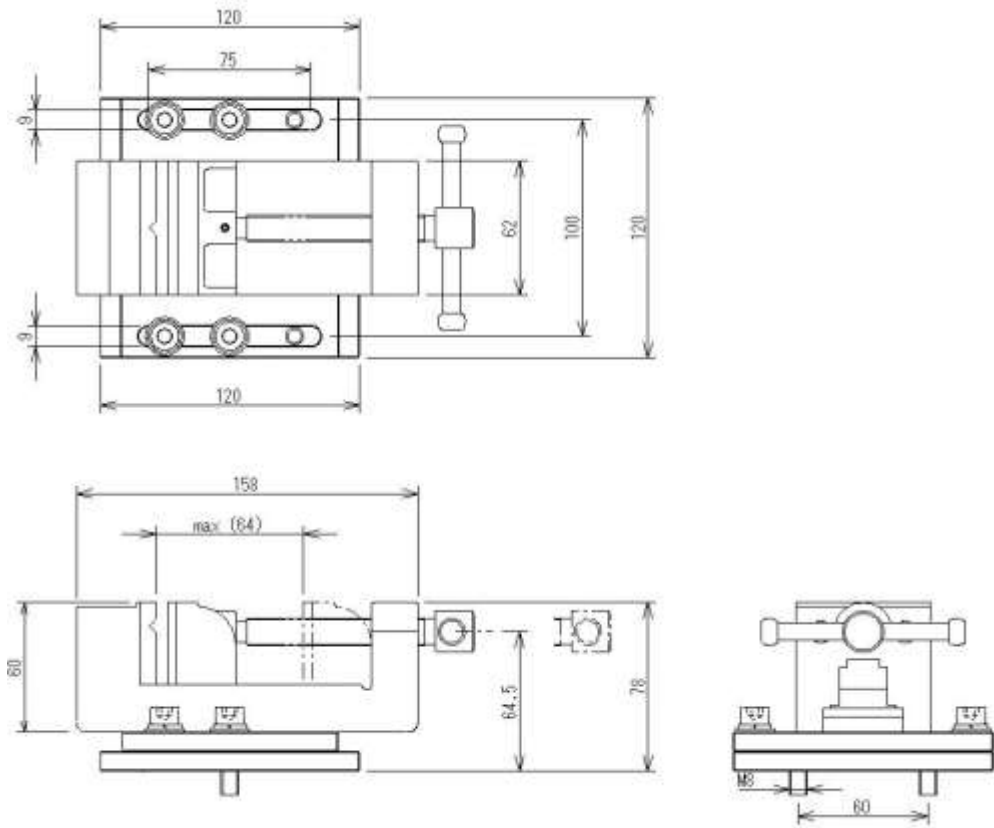

[Caution]

The contents may be changed without notice in advance.

This product is designed for force measurement only. Do not use if for other purposes.

Some samples may not be able to be gripped depending on materials and shapes.

Do not copy and use the contents without authority.

April 05, 2012